

FASAD MOT _____

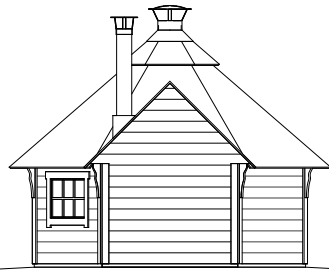

FASAD MOT _____

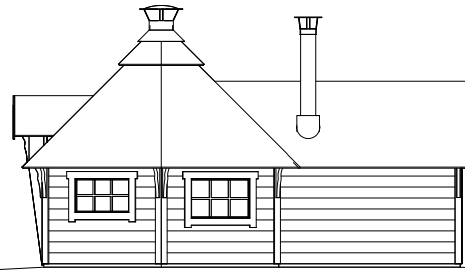

FASAD MOT _____

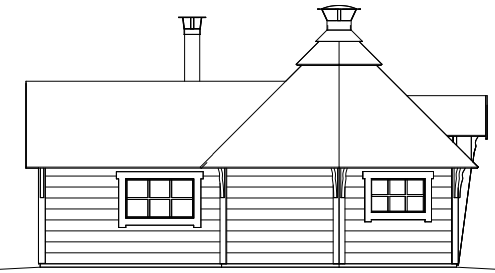

FASAD MOT _____

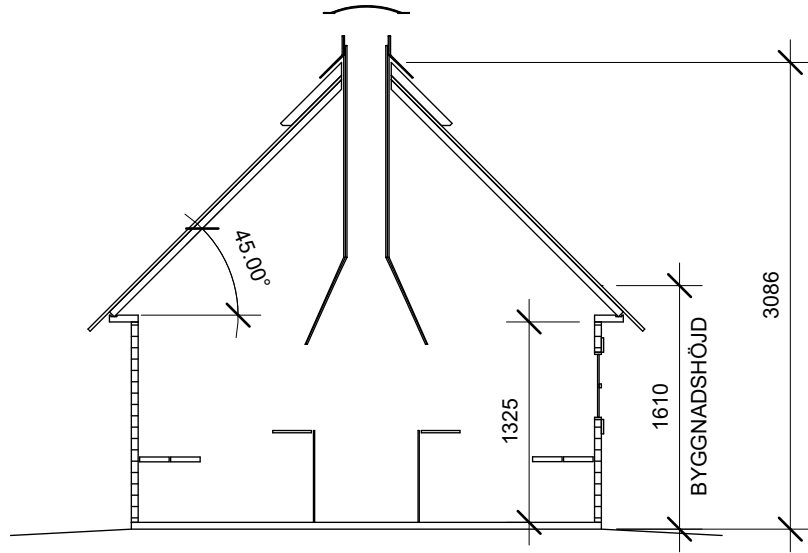

SEKTION GRILLKÅTA (1:50)

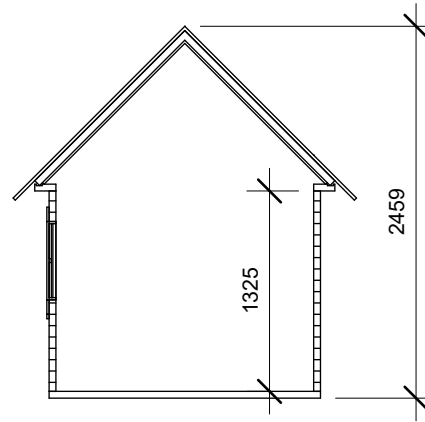

SEKTION BASTURUM (1:50)

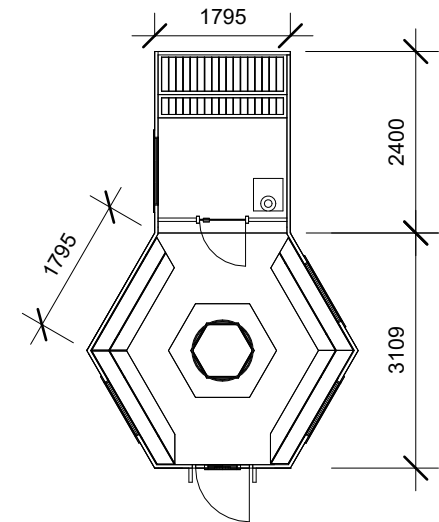

PLAN
BYA 12,67 M²

SKALA 1:100

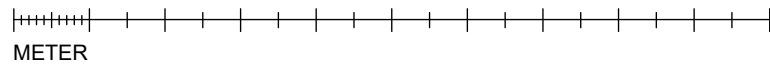

METER

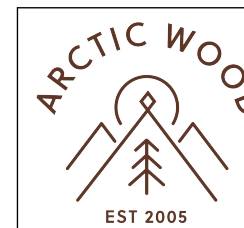

FASTIGHETS BETECKNING				
BYGGHERRE				
GRILLKÅTA MED BASTU, NELLY 13,5			BYGGLOVS RITNING	
PLANRITNING, FASADER, SEKTION				
RITAD AV	ÅH	REV	SIDA	1 / 1
SKALA	1:100	DATUM	2024-06-24	RITN.NR. A-01