

FASAD MOT \_\_\_\_\_

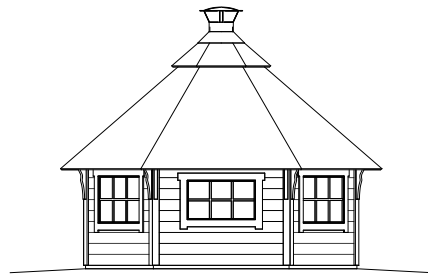

FASAD MOT \_\_\_\_\_

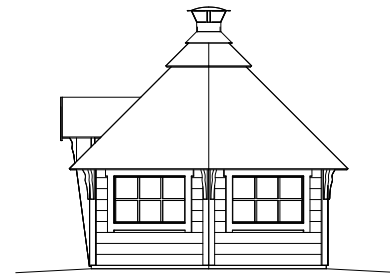

FASAD MOT \_\_\_\_\_

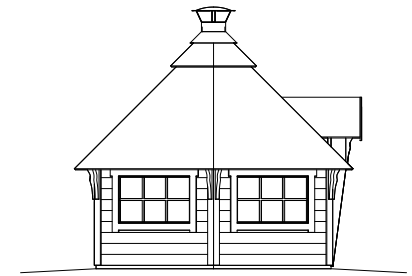

FASAD MOT \_\_\_\_\_

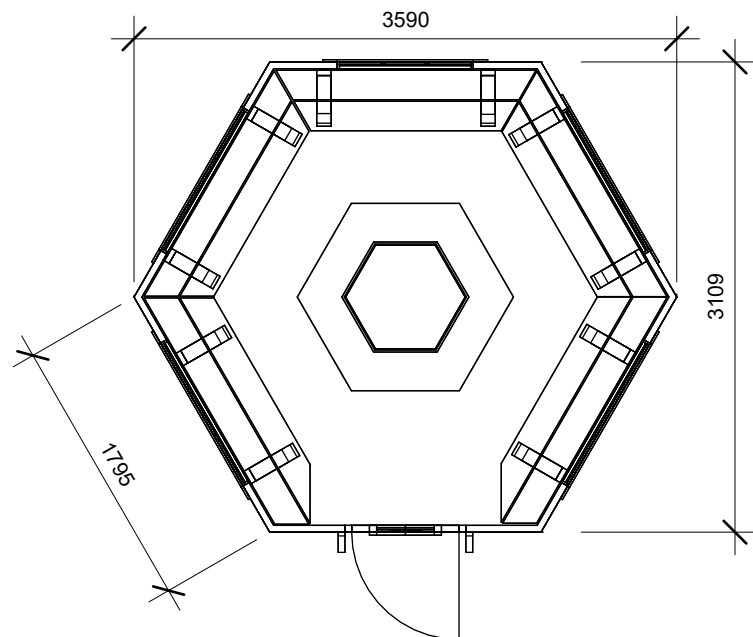

PLAN (1:50)

BYA: 8,37 M<sup>2</sup>

SKALA 1:100

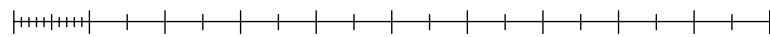

METER

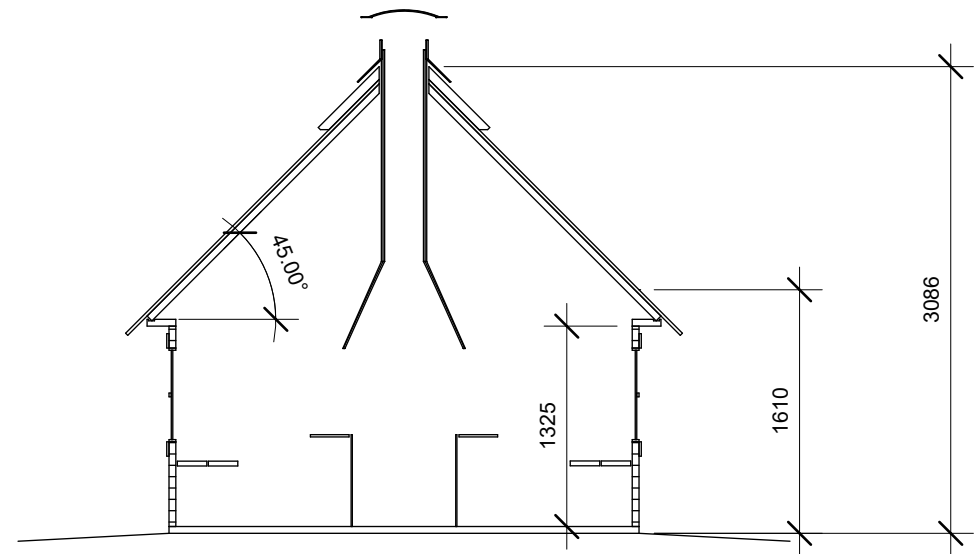

SEKTION (1:50)

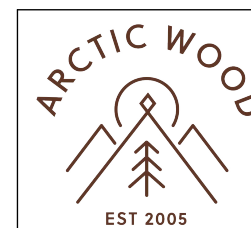

FASTIGHETS BETECKNING			
BYGGHERRE			
GRILLKÄTA SELMA 9,2		BYGGLOVSRITNING	
PLANRITNING, FASADER, SEKTION			
RITAD AV	ÅH	REV	SIDA 1 / 1
SKALA	1:100	DATUM	2024-06-13 RITN.NR. A-01